

Museum Quality Light.

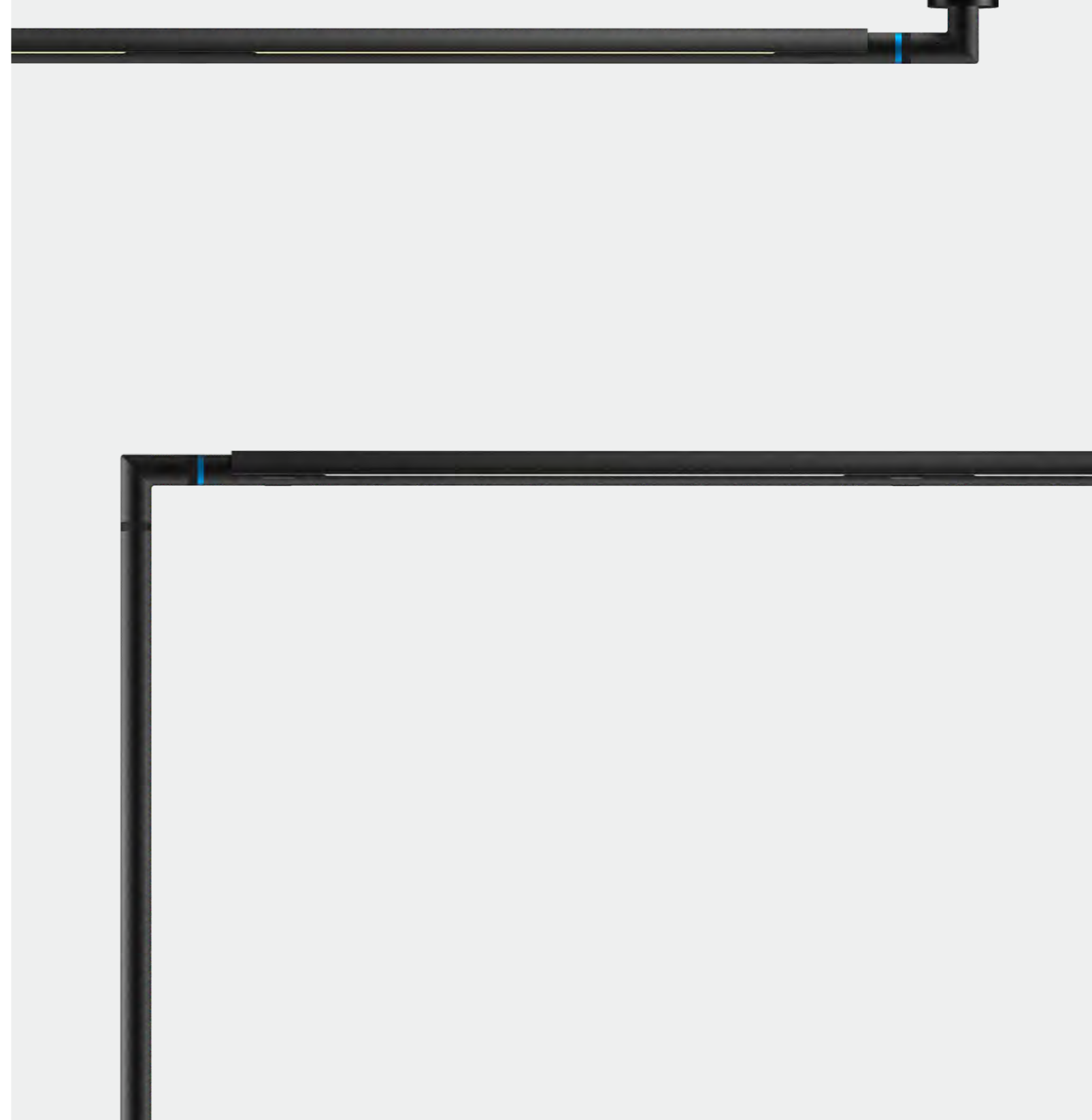

Art. No. 039516.208

Project: Museum of the Communist Party of China  
Location: Chaoyang District, Beijing, China  
Project Year: 2021  
Lighting Equipment: Tracron M6, Sprite X11



Sprite X11 Linear Cabinet Light  
"Zero Glare", continuous and  
uniform flat lighting for  
museum cabinet.

Specifications and  
lighting distribution  
data

[akzu.com](http://akzu.com)

**akzu**



Visit [akzu.com](http://akzu.com) for the latest product information.  
For detailed product specifications and museum lighting design,  
please send your kind inquiry to [info@akzu.com](mailto:info@akzu.com)



Sprite X11 linear cabinet light, ingenious design, perfect glare-free lighting for museum cabinets, continuous and uniform lighting of extra long showcases.



AKZU Sprite X11 linear cabinet light is specially designed for the "perfect non-dazzling" lighting of large and medium-sized flat cabinets in museums and galleries. Extremely slim lamp body of dia. 1cm, lighting direction arbitrarily adjustable, light, thin and flat shade casing, Sprite X11 precisely controls the light and accurately projects on precious cultural relics without glare. Highly uniform and transparent light color, makes the design and implementation of museum flat cabinet lighting very simple. It is not only suitable for the flat display of large-scale plane exhibits, but also suitable for the display design of compact arrangement of multiple exhibits in flat cabinets.

Wattage: 9W, 12W, 15W, 18W, 21W  
 LED module: LEDs on metal-core PCB, optical diffusion lens, LED life span over 50000 hours.  
 Beam angle: table washing, wallwashing.  
 Color temperature: 3000K, 4000K, optional 2700K, 3500K, etc.  
 Color rendering index: CRI 95  
 Luminous flux: 660lm~1680lm  
 SDCM: 2 step MacAdam  
 Installation method: stand mounting, surface mounting, wall mounting  
 Rotation & tilt: 360° vertical adjustment.  
 Control mode: Group dimming, DALI, Phase-cut dimming, Bluetooth dimming, and etc.  
 Brightness control range: 0-100%.  
 Color: white, black, customization optional  
 Housing: machining aluminum alloy, anodized



High CRI



2 step MacAdam

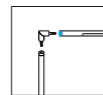

Quick access port

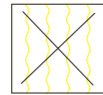

No flicker



360° vertical adjustment



Group dimming



Shade casing component

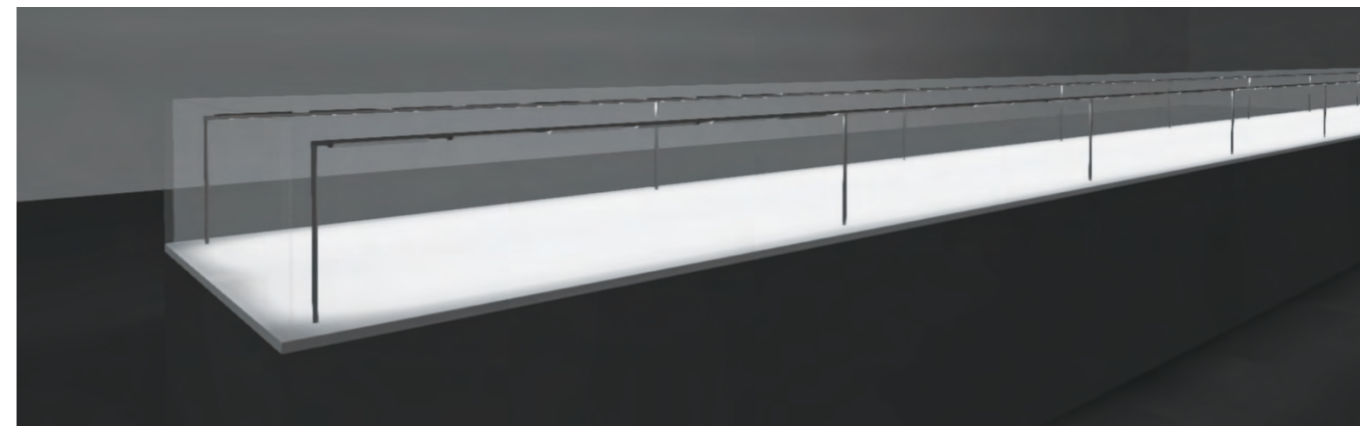

"Zero Glare", continuous and uniform flat lighting for museum cabinet. Extremely slender lamp body with diameter of only 1cm, Sprite X11 may be the world's slimmest museum display cabinet light, can

well hide in the exhibition cabinet space. The light, thin and light shade casing can be freely adjustable according to the viewing angle of the audience, realize non-dazzling of museum flat cabinet and

table cabinet lighting.



adjustable shade casing



stand mounting

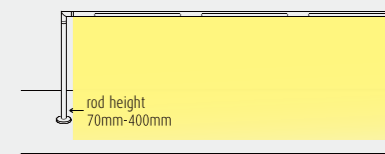

surface mounting



wall mounting

Elegant shade casing. The elegant shade casing, designed based on Fibonacci helix principle and adopts carbide steel and calendaring technology, is only 1mm thin but quite straight.

With dark black coating, it adheres to the lamp body and becomes the first "hacker" to eliminate glare.

All installation procedures are completed on the display board. You only need to make the line hole at the exact position, fix the mounting base, the standing rod will pass through the line hole

and firmly adsorb on the mounting base.

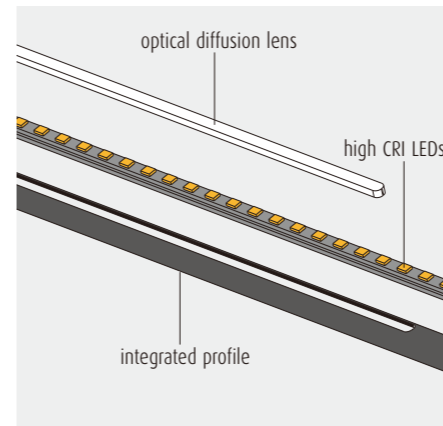

optical diffusion lens

high CRI LEDs

integrated profile

Highly integrated optics in such a slim space. Precise arrangement of high CRI chips, precise selection of aperture size and location, together with optical diffusion lens, Sprite X11 achieves high

consistency and uniformity, forming a long and continuous optical band.



T-type bridge structure, to achieve continuous lighting of super-long exhibition cabinets. Unique T-type bridge components can be connected to the circuit to get continuous power



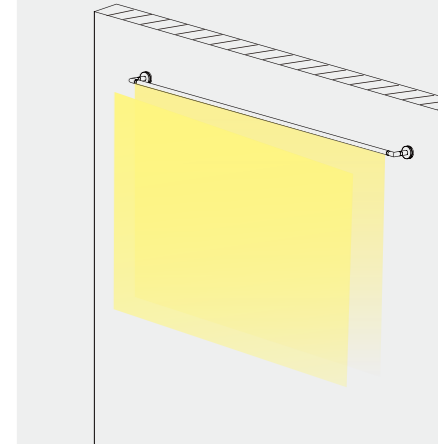

supply for multi-segment lamp body, achieving glare-free table washing lighting of over 100 meters long exhibition cabinet, giving the audience an extremely shocking feeling.

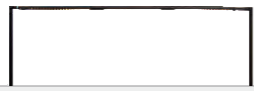

The height of standing rod can be customized within 70-400mm, supporting various installation methods. Sprite X11 supports a variety of installation methods, stand mounting,

surface mounting and wall mounting.

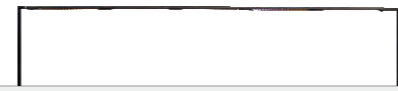
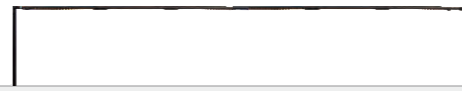
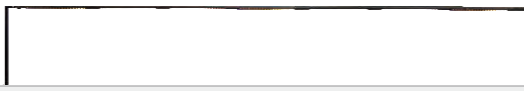
Sprite X11 Specifications and lighting distribution data

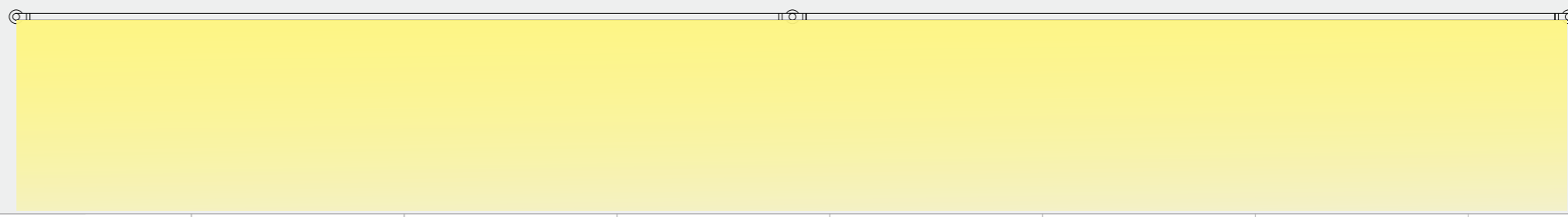
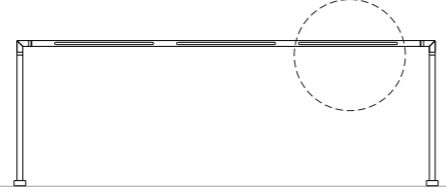
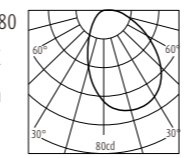
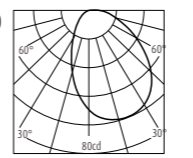
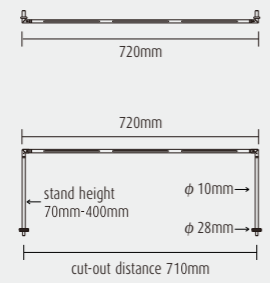
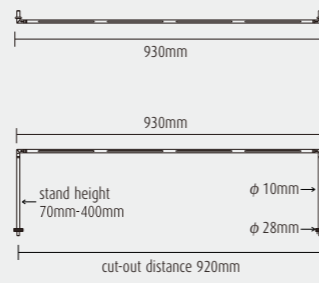
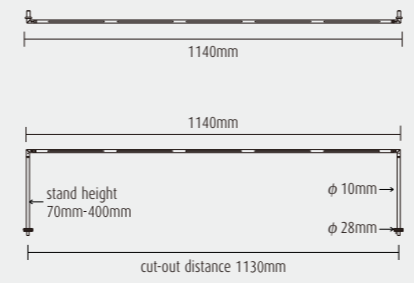
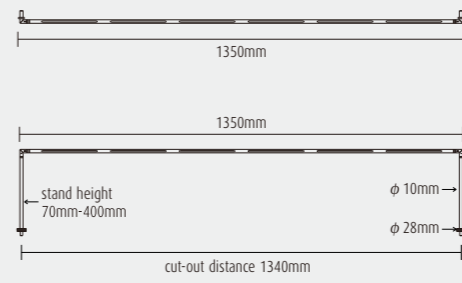
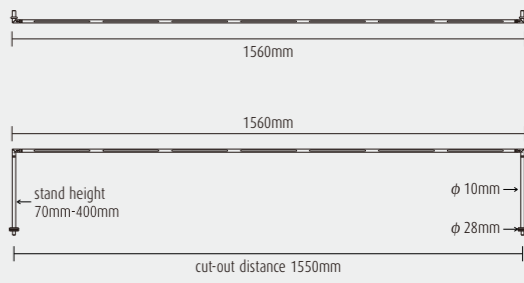
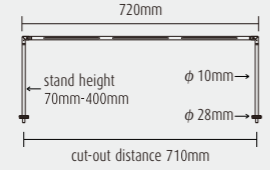
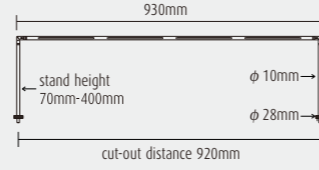
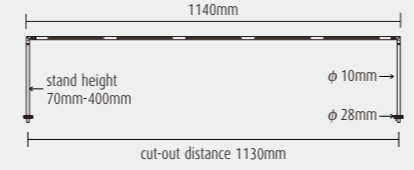
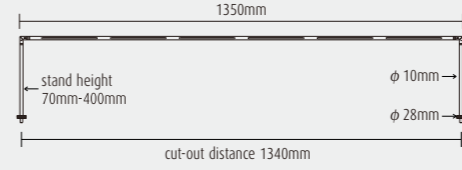
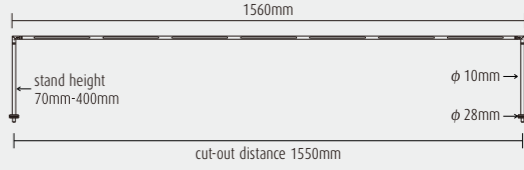
|  |   |  |  |   |  |   |  |   |   |   |  |
|--|---|--|--|---|--|---|--|---|---|---|--|
| Linear Cabinet Light                                       |    |    |                               |    |                               |   |  |   |   |   |  |
| Wattage  | 9W  |  | 12W  |   | 15W  |   | 18W  |   | 21W   |   |  |
| Light type   | Linear washing  |  | Linear washing   |   | Linear washing   |   | Linear washing   |   | Linear washing  |   |  |
| Light type chart   |    |  |                                |   |  |   |  |   |   |   |  |
| Color temperature <sup>1</sup>                             | 3000K   | 4000K  | 3000K  | 4000K   | 3000K  | 4000K   | 3000K  | 4000K   | 3000K   | 4000K   |  |
| CRI  | 95  | 95   | 95   | 95  | 95   | 95  | 95   | 95  | 95  | 95  |  |
| Luminous flux <sup>2</sup>                                 | 660lm   | 720lm  | 880lm  | 960lm   | 1100lm   | 1200lm  | 1320lm   | 1440lm  | 1540lm  | 1680lm  |  |
| Unit<br>CO-C180<br>Lighting distribution data <sup>3</sup> |   |  | CO-C180<br>3000K<br>220lm<br> |   | CO-C180<br>4000K<br>240lm<br> |   |  |   |   |   |  |
| Control mode <sup>4</sup>                                  |   |  |  |   |  |   |  |   |   |   |  |
| Group dimming  | ✓   |  |  |   |  |   |  |   |   |   |  |
| Installation method <sup>5</sup>                           |   |  |  |   |  |   |  |   |   |   |  |
| Stand mounting   | ●   |  |  |   |  |   |  |   |   |   |  |
| Ceiling mounting   | ●   |  |  |   |  |   |  |   |   |   |  |
| Wall mounting  | ●   |  |  |   |  |   |  |   |   |   |  |
| Insulation class   | Class III   |  |  |   |  |   |  |   |   |   |  |
| Protection degree  | IP20  |  |  |   |  |   |  |   |   |   |  |
| Voltage  | 12VDC   |  |  |   |  |   |  |   |   |   |  |
| Rotation   | 360°  |  |  |   |  |   |  |   |   |   |  |
| Stand height   | 70mm-400mm ( customizable )   |  |  |   |  |   |  |   |   |   |  |
| Ceiling thickness  | 1-30mm  |  |  |   |  |   |  |   |   |   |  |
| Stand mounting cut-out                                     | φ 8mm   |  |  |   |  |   |  |   |   |   |  |
| Dimension  |    |  |                             |  |                             |  |  |  |  |  |  |
| Article code   |   |  |  |   |  |   |  |   |   |   |  |
| White  | 903002  | 903052   | 903222   | 903272  | 903442   | 903492  | 903662   | 903712  | 903883  | 903884  |  |
| Black  | 903001  | 903051   | 903221   | 903271  | 903441   | 903491  | 903661   | 903711  | 903881  | 903882  |  |
| Note   | <ol style="list-style-type: none"> <li>Besides the standard 3000K, 4000K, other specification is also optional, like 2700K, 3500K, etc.</li> <li>The listed luminous flux data is standard specification, higher light efficiency product can be customized upon request.</li> <li>All data, images, and specifications are typical and for reference only, and may be changed due to product improvement without prior notice.</li> <li>Input voltage is 12V for control mode of group dimming. Phase-cut dimming, bluetooth dimming, DALI and etc are optional.</li> <li>Optional stand mounting, surface mounting and wall mounting, depending on the actual project construction drawings.</li> <li>For more information, please visit us at akzu.com.</li> </ol> |  |  |   |  |   |  |   |   |   |  |

# Sprite X11 Linear Cabinet Light

## Stand mounting A

| Wattage | Cut-out distance | Cut-out |
|---------|------------------|---------|
| 9W      | 710mm            | ∅8mm    |
| 12W     | 920mm            | ∅8mm    |
| 15W     | 1130mm           | ∅8mm    |
| 18W     | 1340mm           | ∅8mm    |
| 21W     | 1550mm           | ∅8mm    |

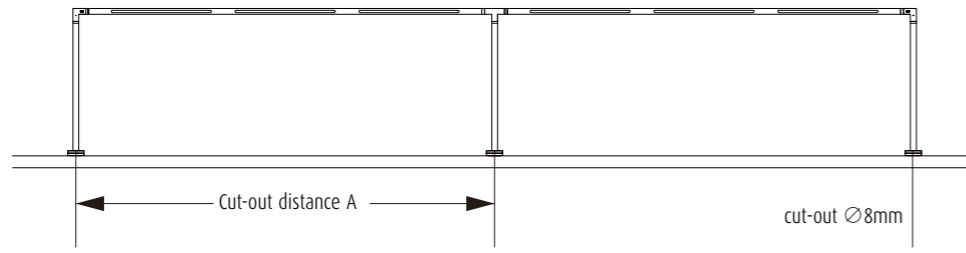

## Ceiling mounting B

| Wattage | Cut-out distance | Cut-out |
|---------|------------------|---------|
| 9W      | 710mm            | ∅10mm   |
| 12W     | 920mm            | ∅10mm   |
| 15W     | 1130mm           | ∅10mm   |
| 18W     | 1340mm           | ∅10mm   |
| 21W     | 1550mm           | ∅10mm   |

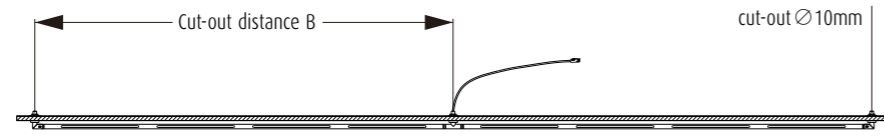

The package contains two kinds of accessories: magnetic ring and non-magnetic base. Please read the instruction manual carefully before installation in order to avoid product damage!

## Installation on non-magnetic materials

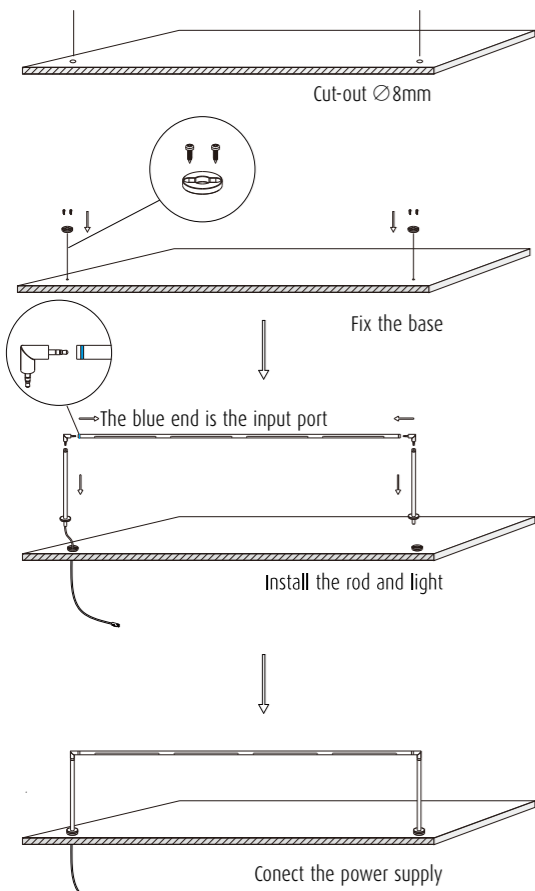

## Installation on magnetic materials

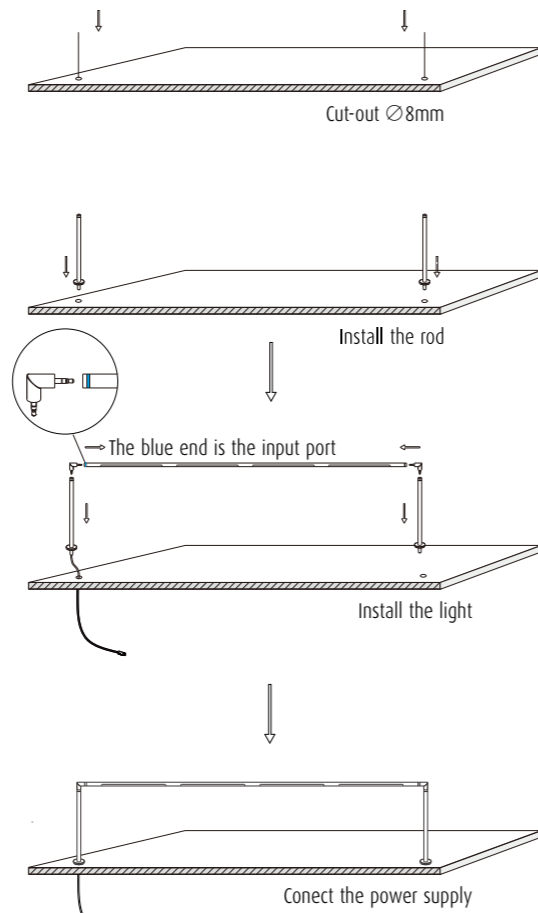

## Surface mounting

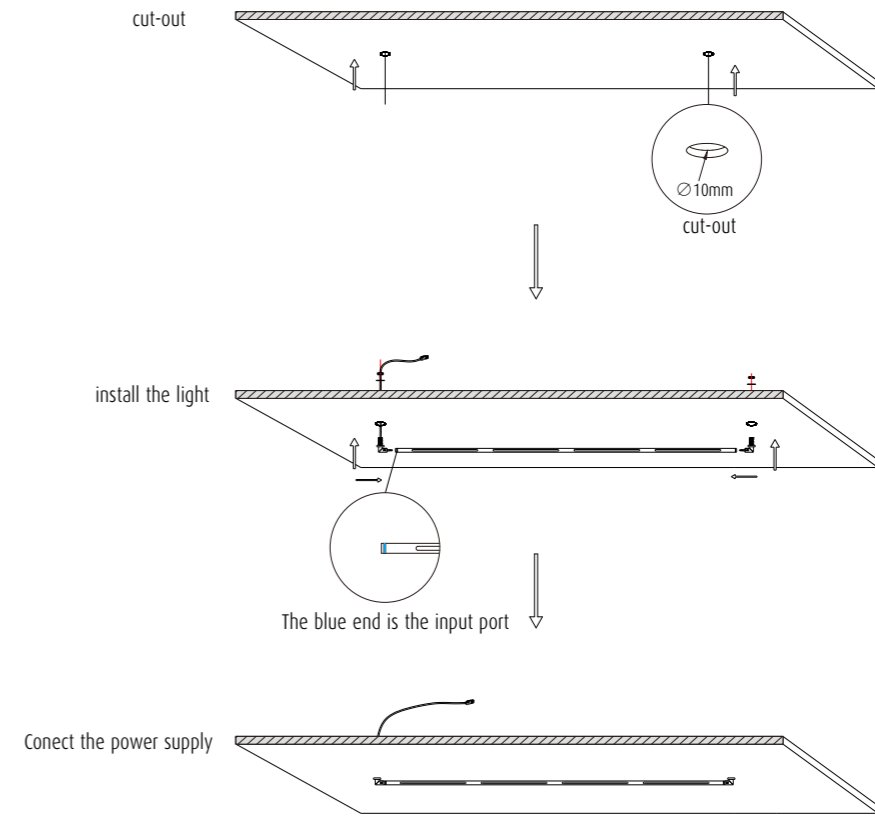

\*For guide to continuous assembling, please refer to Sprite X11 instruction manual.

## Shade casing component

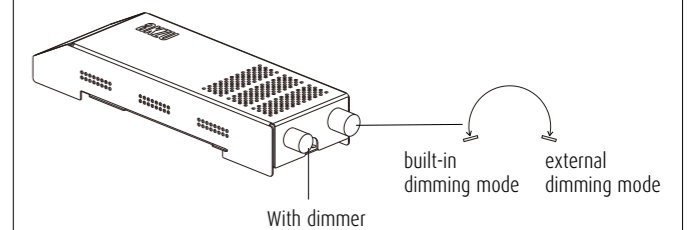
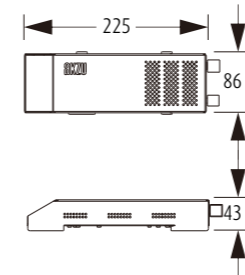
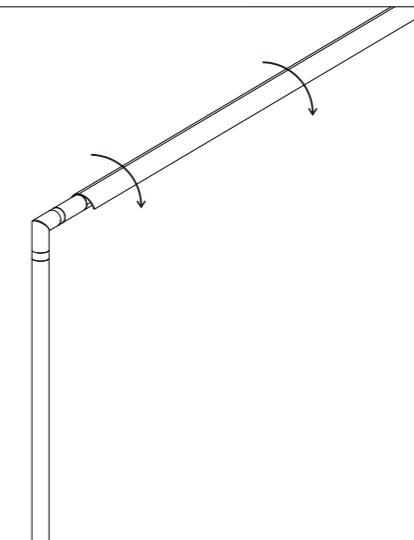

# Sprite X11 Linear Cabinet Light

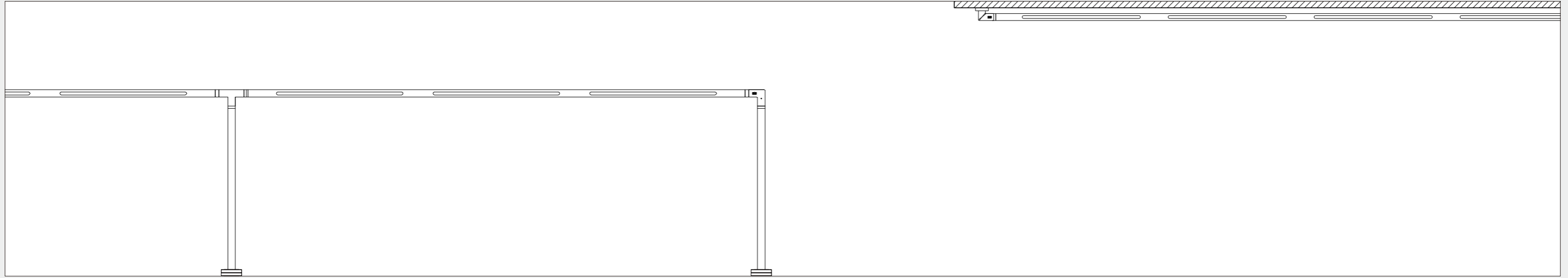

## Sprite X11 product customization

Color temperature



2700K  
CRI 95



3500K  
CRI 95

Higher light efficiency



3000K



4000K

Control mode



Phase-cut  
dimming



Bluetooth  
dimming

Color



Customized color (Pantone color number)

For more product information, please visit us at [akzu.com](http://akzu.com).